

If the frame-glass allowance is too large the spacer may show under the lip at the top of the frame.

For full info on the products shown here visit our website: lionpic.co.uk

See PUB105

For a full listing of the EconoSpace, FrameSpace and RabbetSpace ranges

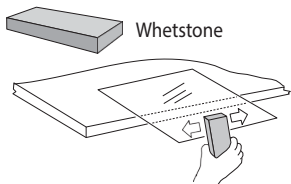

Before you clean the glass, "swipe" the edges of the glass with a hand seamer, whetstone or Telum pad. 1047

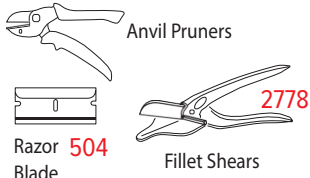

Anvil Pruners work the best to get good, clean, flush cuts.

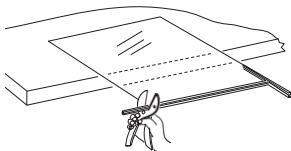

Use a small piece of FrameSpace as a gauge for determining spacing of the first side. Cut the FrameSpace on the glass.

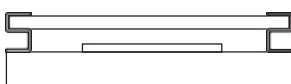
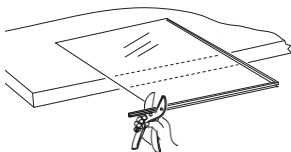

Stack the glass, FrameSpace, art and backing package FACE UP and check for dust and critters.

1. Before you cut the glass, consider that the FrameSpace will add about 1.5mm, to the size of the glass. Although the industry standard 3.00mm, frame-glass allowance will usually work just fine, the glass and the spacer will end up resting on the bottom section of the frame and the top spacer may show under the lip at the top of the frame. You may find that 2.5mm, allowance will work better in most frames. It is OK for the glass and the backing to be different sizes, as the backing needs more room for free expansion. The preferred method is to "float" the art rather than have the FrameSpace in direct contact with it. This will help prevent buckling and abrasion.

2. A couple of strokes on the edges of the glass with a Telum pad, 1047, whetstone or glass seamer will make it easier, faster and safer to apply the FrameSpace. This simple step will save you a lot more time than it takes. (This trick really helps in day-to-day framing too, as it keeps the glass from shaving bits of wood, paint or leaf off wood frames and helps prevent glass from chipping in metal frames.) This also keeps the glass from shredding fibers off the glass cleaning rag. It's safer ... no more bandages!

3. FrameSpace is best cut with Anvil Pruners (rose cutters). Sharp fillet shears or a razor blade will also work. Scissors, bypass shears or wire cutters will crush the FrameSpace.

4. After swiping and cleaning the glass, attach a small piece of FrameSpace to one corner of the glass to use as a gauge for applying the first side. Apply the first side against the gauge piece and cut the other end off flush with the glass as shown. If using Anvil Pruners, put the sharp blade against the glass and the anvil feature against the FrameSpace.

5. Apply the second piece of FrameSpace tight against the end of the first piece. Cut it flush with the edge of the glass and continue likewise around the glass.

6. Set the clean glass with the FrameSpace attached down onto the art and backing assembly. Check for dust, glass smudges and critters.

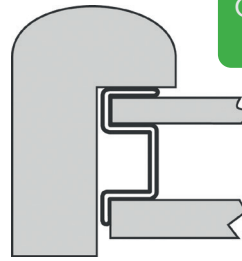

Lower frame down over entire package.

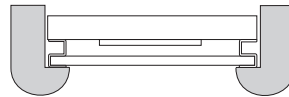

Turn frame over and fit as usual.

Check best prices: lionpic.co.uk

PUB069
V.4 01/2021

7. Put the frame down over the entire glass/art/backing package. In a metal frame, slide the whole glass/art/backing package in, face up.

8. Turn the whole package over and finish off the frame as usual. Minimize any downward pressure with your fitting staples, diamond points, flex points, etc., as the backing must be free to expand and contract with changes in humidity. In metal frames, hot glue or ATG strips of scrap mat or foam board rather than using the spring clips. Leave it all slightly loose for expansion. Rattling beats buckling.

Create Different Looks with FrameSpace



Spray paint the BACK side to match or complement so the paint won't rub off on decorative background.

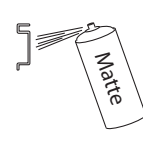

Spray Matte acrylic or lacquer on the FRONT side for matte finish. Wipe down with water and alcohol 50/50 first for best finish.

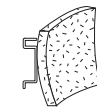

Get a nice matte finish with a ScotchBrite® or similar pad. 3549

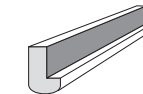

Paint, stain or "paper" the inside of the rabbet and use clear FrameSpace.

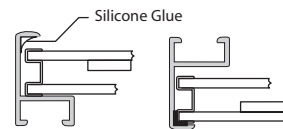

Silicone Glue

For double glazing in metal frames, minimize the glass/frame allowance, use FS 1/4 Dbl., 3542, and bond glass/art/FrameSpace package into frame with a bead of silicone glue under frame lip. Apply glue to the frame, assemble frame face up, rest face down overnight to cure.

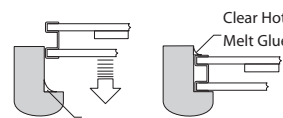

Clear Hot Melt Glue

For double glazing in wood frames, minimize the glass/frame allowance and either bond FS 1/4 Dbl., 3542, into frame with silicone glue under frame lip or with clear hot melt glue behind the FrameSpace.

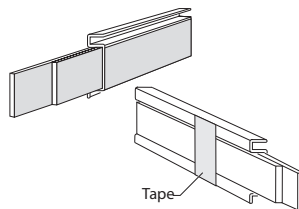

Tape

Fill back of FrameSpace with 2 layers of matboard (to fill space completely). Keep in place with strips of tape every 200mm or so to hold until in frame. Apply to glass and cut through FrameSpace and mats at the same time with anvil pruners. Mat strips can expand and contract without buckling or sagging into frame. This is faster and easier than gluing material into the rabbet and is mechanically permanent, as well as removable.

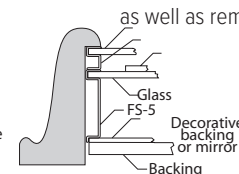
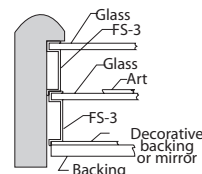

Here are two examples of art or objects framed "floating" well above a decorative backing or mirror. Coins, bills, postcards, sea shells, playing cards, etc.

Attach the art to the second piece of glass. Non-reflective type glass really makes this framing sing. Use mirror tiles for smaller jobs because they are thin, lightweight and inexpensive.



EconoSpace®

Sticks on

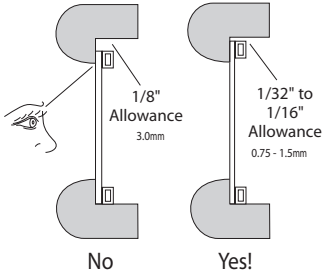

For full info on the products shown here visit our website: lionpic.co.uk

See PUB105

For a full listing of the EconoSpace, FrameSpace and RabbetSpace ranges

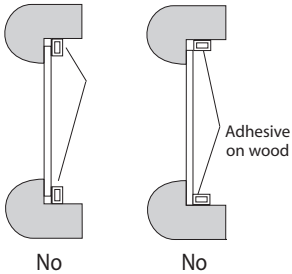

Centering the glass in the frame with the EconoSpace or bonding to the rabbet will result in early adhesive failure.



Clean the glass with water and alcohol or Lion Glass Cleaner.

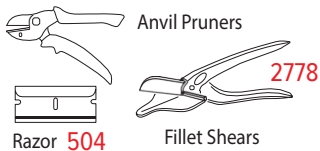

Anvil Pruners work the best to get good, clean, flush cuts.

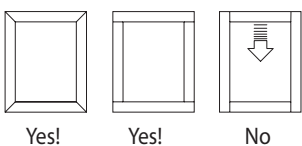

1. Gravity will insist that the glass (with the EconoSpace attached) will end up resting on the bottom piece of frame. If too much glass/frame allowance is used, the EconoSpace may show under the lip of the top piece of frame. Decreasing the glass/frame allowance by increasing the glass size will remedy this problem and still allow proper frame allowance for the art and backing. It's okay for the glass size to be different than the backing.

Because gravity pulls down on the top spacer every day, we recommend using EconoSpace only on smaller frames (less than 750mm, 30"), where the inherent stiffness of the EconoSpace will prevent it from sagging. On larger frames, consider FrameSpace as it is mechanically permanent and can't sag.

2. If you use 3.0mm, 1/8", allowance and "center" the glass with the adhesive half-on and half-off the glass, expect early adhesive failure as the weight of the glass will shear the bond. The top spacer will only be engaging half of the adhesive so it will probably not beat gravity either.

Bonding to the rabbet/frame will also result in early adhesive failure because the lignin in the wood will eventually degrade the adhesive. (This is why using Pressure Sensitive Tape to bond matboard strips to the rabbet never lasts very long). Pressure on the glass during cleaning will also shear the adhesive.

3. To ensure the best bond strength and longevity, the adhesive manufacturer, 3M® Company recommends cleaning the glass with a 50-50 mix of water and alcohol (methylated spirit). Most household glass cleaners include waxes or polishes which will prevent a great bond.

4. EconoSpace can be cut easily with sharp Anvil Pruners (rose cutters), a razor blade or fillet cutters like shown. EconoSpace can also be chopped or cut with a fine tooth saw. Scissors, wire cutters or bypass type shears will crush the EconoSpace.

5. Either miter the EconoSpace or cut butt joints like shown to support the top piece at the ends. This will help prevent sagging at the corners when the adhesive finally gives up against gravity.

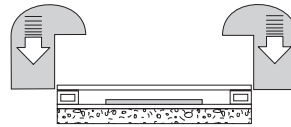
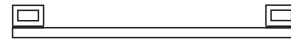
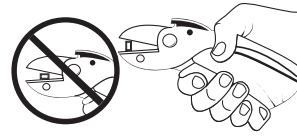
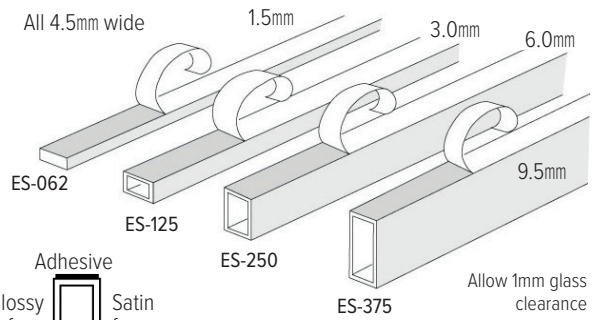

Place the frame down over the whole "package."

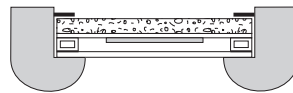

Turn the frame over and fit as usual.

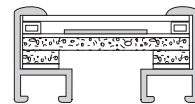
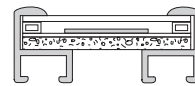

Rather than spring clips, fill the back to prevent buckling.

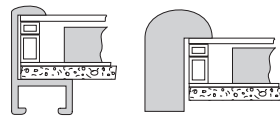

EconoSpace can be stacked for thicker art or artifacts.

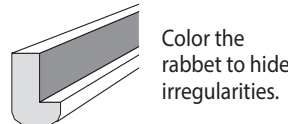

Color the rabbet to hide irregularities.

6. When cutting EconoSpace, you'll get a better cut if you cut it "on edge," as shown, rather than lying flat. Sharp Anvil Pruners (rose cutters) work the best for butt joints. A chopper or fillet chopper works best for mitred joints.

7. Apply the EconoSpace flush with the edge of the clean glass. Pressure sensitive adhesives are sensitive to pressure so press hard when applying the EconoSpace to the glass to get the best adhesive strength and longevity.

8. Flip the glass over and stack it on top of the art and backing. Check for dust, glass smudges and critters.

9. When everything is clean, put the frame down over the entire glass/EconoSpace/art/backing package.

10. Turn the frame over and fit as you would a regular frame job. Avoid applying any pressure against the backing with fitting points or staples (or spring clips in metal frames). The art, mats and backing board must be absolutely free to expand and contract with changes in humidity. Any pressure will cause buckling.

11. In aluminium frames, either fill the back of the frame completely with backers and fillers or adhere 9.5mm, 3/8", wide strips of backing or filling materials to the edge of the backing. If you use spring clips or stuff strips of foam board in the back of the frame, the pressure around the edges will cause buckling. Rattling beats buckling!

12. You can stack EconoSpace to get more airspace but you may find FrameSpace less expensive, more secure and easier to use for deeper frame jobs.

13. With clear EconoSpace, consider coloring or darkening the rabbet, as any irregularities in the rabbet coloring may show from the front.

EconoChopper

This measures EconoSpace up to 1520mm / 60" then accurately cuts it with a replaceable blade. Includes a pack of 5 single bevel razor blades. Check out 9780 on our website.

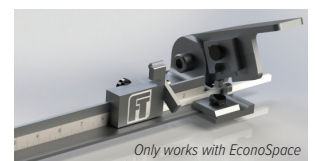

LION Picture Framing Supplies Ltd
148 Garrison Street, Birmingham B9 4BN
Tel: 0121 773 1230 info@lionpic.co.uk
Open 08.45 - 17.00 Monday to Friday

lionpic.co.uk

Product information updated January 2021



FrameSpace



EconoSpace